

Partnr. 34B-F84A8-XX







USER GUIDE









39L Top case



50L Top case

Posnr.	QTY	
①	1	 39L
②	1	 5B2-F413B-00
③	1	 16P-F8338-00
④	2	 M3 x 8 mm
⑤	1	
⑥	1	 NOT INCLUDED 52S-21780-09
⑦	1	 NOT INCLUDED * OPTION 59C-281C0-00

Posnr.	QTY	
①	1	 50L
②	1	 5B2-F413B-00
③	1	 16P-F8338-00
④	2	 M3 x 8 mm
⑤	1	
⑥	1	 NOT INCLUDED 52S-21780-09
⑦	1	 NOT INCLUDED * OPTION 59C-281C0-00

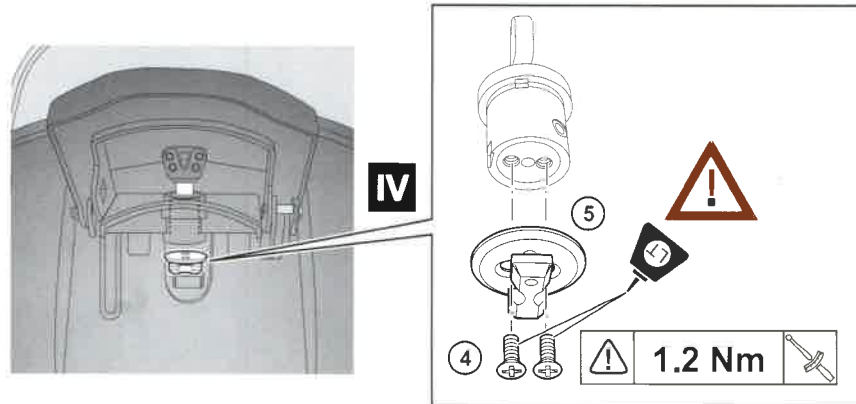
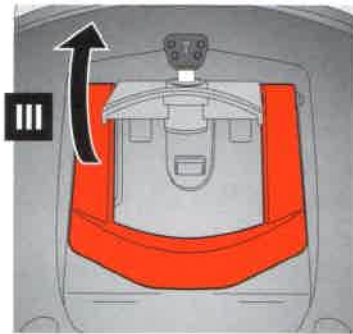
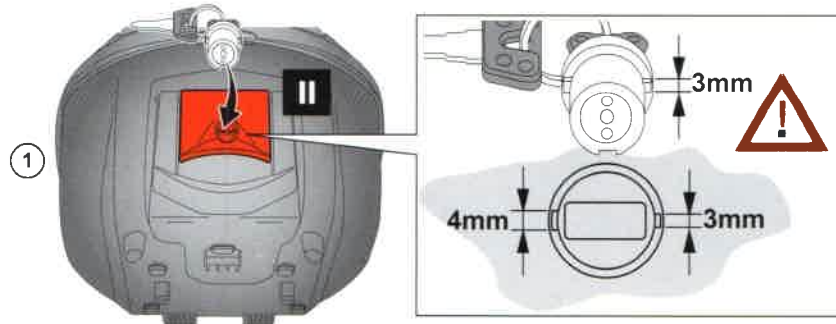
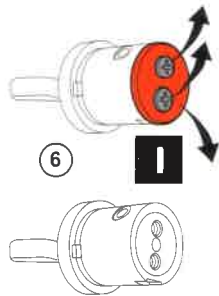

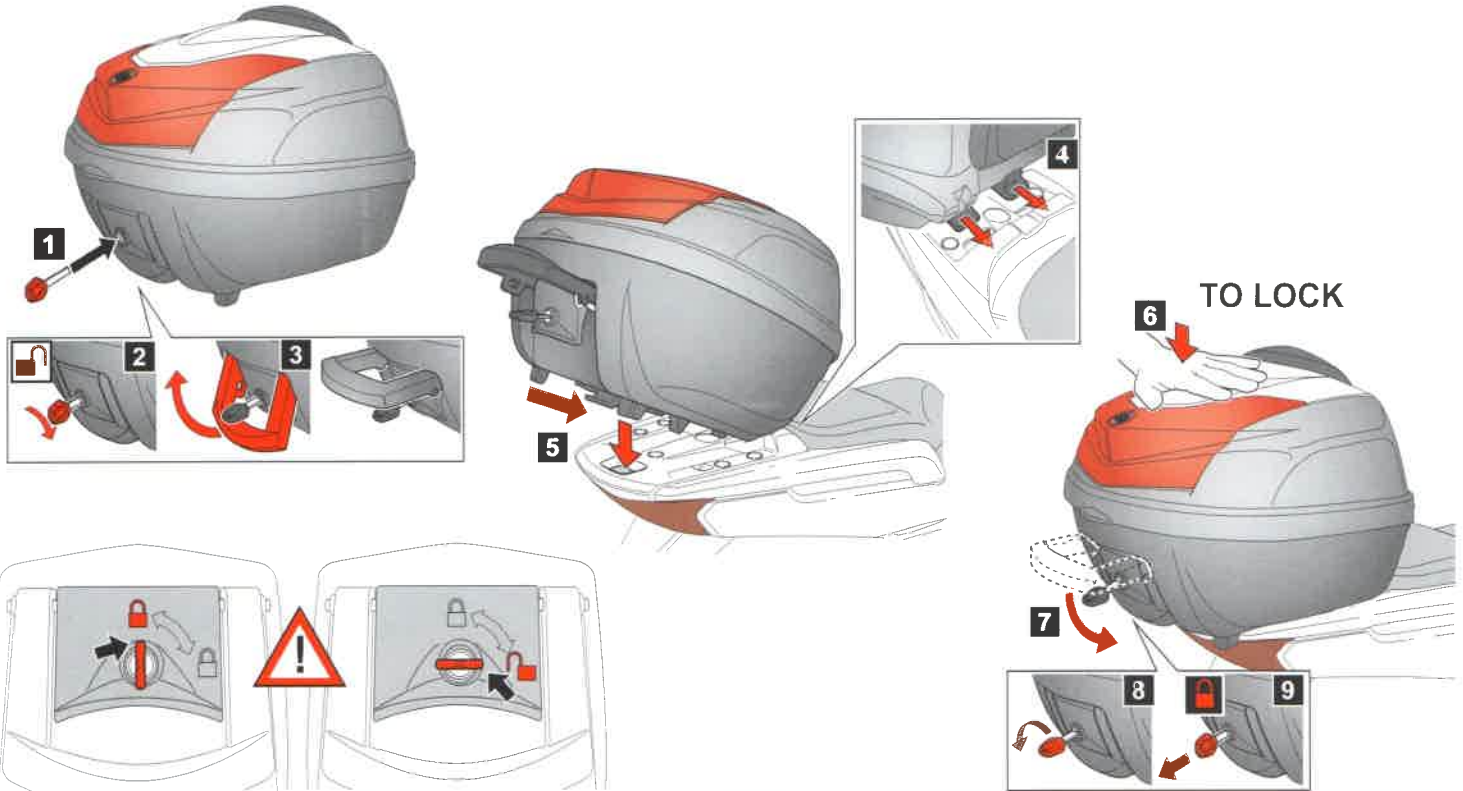

TO OPEN

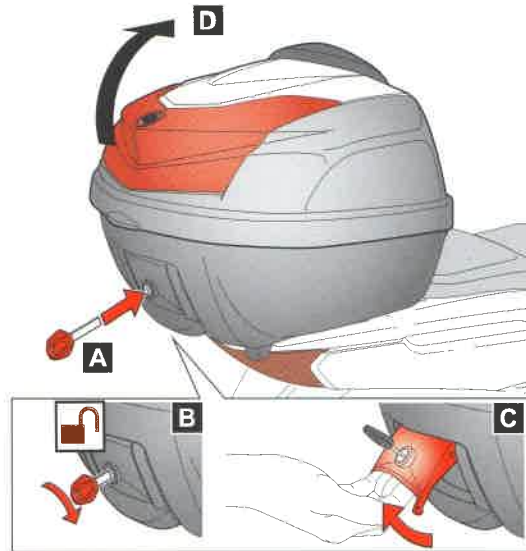

TO CLOSE

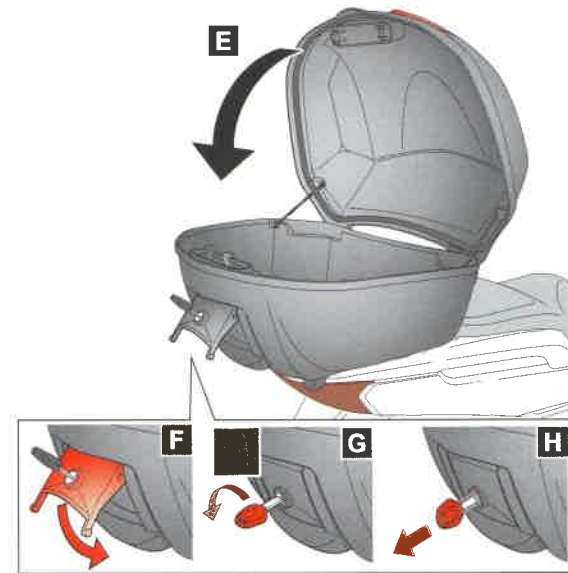



Yamaha Top Case 39L

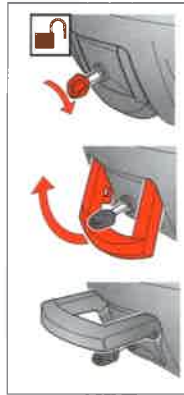
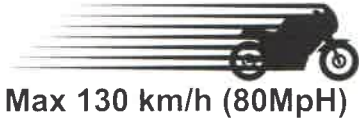

Yamaha Top Case 50L

